



## Goedhart VCI

Industrial air coolers for cooling & freezing applications

Cu/Al

R404A - CO<sub>2</sub>



# Goedhart VCI

The extensive range Goedhart VCI single discharge ceiling mounted industrial air coolers are available with capacities between 2,8 and 264,4 kW. The Goedhart VCI air coolers are suitable for cooling and freezing applications and with a wide variety of accessories and options available. The coil block is standard build from aluminium end plates, copper tubes and aluminium fins. The fans are arranged for blow-through air configuration for the Goedhart VCI-B and draw-through for the Goedhart VCI-Z (please state which is required when ordering).. The modular design incorporates 5 different sizes of fan, with model options of up to 8 fans per cooler.

## Type description

### Goedhart VCI-B 62567

B=blow through  
Z=draw through

Number of rows deep  
Number of fans  
Fan diameter [cm]  
Fins spacing [mm]

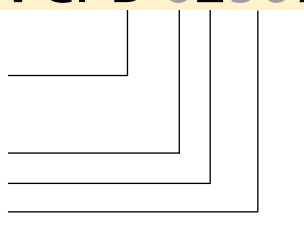

## Coil block

- Tube pitch : 50x50 mm straight
- Fin spacing : 4, 6, 7, 8, 10 and 12 mm
- Material : 15mm o.d copper tube
- : aluminium HT-lamellen
- Optimized cooling circuits
- Standard refrigerant connections are positioned on the left hand side of the unit when looking with the direction of the airflow.
- A good thermal contact is achieved by expansion of the tubes into the fin collars, that are also utilised as spacers to provide a constant distance between the fins.
- All coolers are pressure tested to 30 bar (lower by cooling mediums) and are supplied with a light over pressure charge of dry nitrogen.
- Suitable for all known refrigerants and coolants, with the exception of NH3.

## Casing

- Construction for ceiling mounting
- The flush mounting protects against and prevents accumulation of dust and dirt.
- Casing material of galvanized sheet steel
- Finishing is standard white epoxy spray (RAL 9003)
- Bend/header projection by end covers, easy removed for maintenance
- Defrost by hot gas spiral or electric defrost elements will be fixed to the bottom side of the coil.
- Stainless steel fasteners

# General range features

## Capacity

The listed nominal cooling capacities are based on R404A, DT1, RH of 85% and 4 pole 3 phase fans connected in Δ.

### Influence of Coating on Capacity

The use of coated fins, or of a fully coated coil will result in a capacity decrease of approximately 3%

### Capacity optimisation

Since Goedhart tries to limit stock products, we are capable of optimising the circuitry of our evaporators. In order to do this, the following information is needed :

- Design capacity
- Air volume
- Refrigerant
- Air on temperature
- Evaporating temperature
- Liquid temperature before expansion valve.

## Sound data

The mean sound pressure (LpA @ 3m ± 2 dB (A)) each air cooler is a calculated indication value according to the EN13487 standard parallel pipe. Goedhart uses the fan manufacturer's sound power level (LwA) at the inlet side of the fan. Changes to or by the fan or the product, affect the sound, in these cases, consult the manufacturer for the new indication value. In critical sound requirements, we advise you to consult an expert.

## Defrostsystem:

For room temperatures where ice build-up can be expected and where the coilblock can not be defrosted by the room air, electric or hotgas defrost is necessary.

With low temperatures we also advise fan periphery heating.

### Electrical defrost:

The Goedhart VRB and VRZ can be provided with electric defrost. A distinction can be made here between heavy defrost loads for low temperatures and light defrost load for higher temperatures (room temperature approximately 0 °C). The stainless steel heater elements are fitted in the coilblock in tubes, which forms a high conductive medium between the heaters and the fins. The driptray heaters are fitted to the underside of the aluminium inner tray with aluminium profiles. The heater elements which are rated for 220/240 V are connected for supply 380/415 V with neutral. The coilblock elements are removable from the end opposite to the refrigerant connections, whilst the tray heater elements can

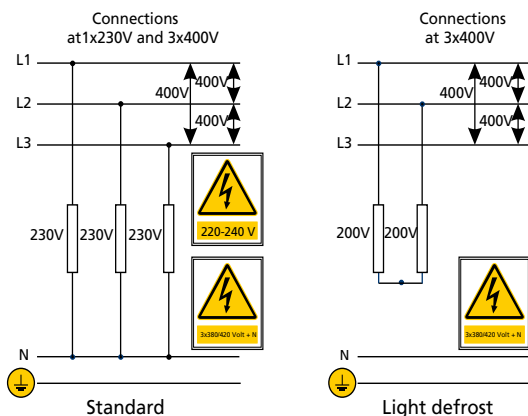

be removed once the outer tray has been taken off.

### Hot gas defrost:

The coil block is suited for hot gas defrost (hot gas supply through the suction header). At an extra price the driptray can be provided with a hotgas/cooling medium spiral. The stainless steel tubes of the hotgas spiral are enclosed in special aluminium profiles that are rigidly secured to the underside of the aluminium inner tray, thus providing a good bond for maximum heat transfer. Just as with electric defrost a distinction is made with hotgas defrost between light defrost load (room temperature about 0°C) and heavy defrost load.

## Accessories:

Standard accessories for the Goedhart VCI air coolers are:

- blow-through / draw-through air configuration
- Electric defrost, hot gas defrost and/or water defrost
- Fan periphery heating
- Hinged drip tray.
- Insulated drip tray
- Insulated hygienic polyester drip tray
- Goedhart VCI-Z supplied with bellmouth connection per fan for a longer air throw
- Goedhart VCI-B supplied with air diffusor for a longer air throw
- Goedhart VCI-B supplied with air diffusor with air operated damper to increase defrost efficiency (airvolume reduced to approx. 90% and capacity reduced to approx. 95%)

The accessories are included in the price list.

## Optional extras:

Various optional extras for the VCI are available, price and delivery upon request:

- Isulation disks
- Feet for floor mounting
- Coating of the coil block
- Fan hood
- Hinged fan plates
- 60 Hz motors
- EC-fans
- Single phase motors
- Coolants (glycol, water, etc.)
- Pump system
- Other casing materials
- Other fin spacings
- Sea water resistant fins

## Mounting and Maintenance

Goedhart VCI is delivered on a wooden frame. When on the frame, Goedhart VCI can be handled by forklift truck, which makes positioning and installation simple. Refer to our maintenance and installation manual.



# Fans

Because of the flexible construction of the Goedhart VCI air cooler, in principle it is possible to deliver with different fans. GEA Goedhart selected a standard fan range of Ziehl Abegg (we reserve the right to alter the manufacturer) which fit perfectly on the Goedhart VCI air coolers. The fans can be supplied in both blow-through and draw-through executions. Against an extra price and with extra delivery times stainless steel guards and EC-fans are available.

## Execution

The fans meet the ErP directive. The fans have very good aerodynamic features because of the special impeller geometry. This special impeller geometry gives the fan a low noise level and an high efficiency.

1x230V fans are suitable for a room temperature till -25°C. 3x400V fans are suitable for a room temperature till -40°C. When lower room temperatures are desired, special fans are need.

- Tension : 3x400V-50Hz-3 phase  
 : 1x230V-50Hz-1 phase  
 (60Hz execution on request)
- Protection class : IP44 / IP54
- Color : RAL9005 (black)
- Speed controlling : - 3 Phase motors are suitable for 2-speed regulation by  $\Delta$ -Y reconnection.  
 - 3 Phase motors are suitable for frequency controller with all-pole sinus filter.  
 - 1 Phase motors are suitable for phase control and transformer.

The motors are standard executed with a thermo contact (TB) and must be connected to prevent motor damages. The maximum allowable working data in the table and on the name plate of the fans are to operate in an air temperature of 20 °C (air density of  $\rho = 1,2 \text{ kg/m}^3$ ). For air temperatures lower then +20 °C, the current amperage can be calculated by using the diagram multiplication factor, suitable thermal overloads can then be selected.

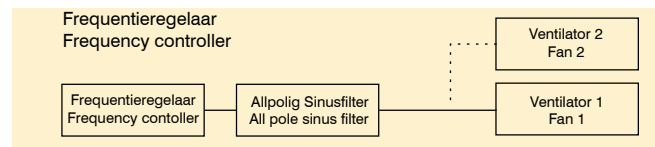
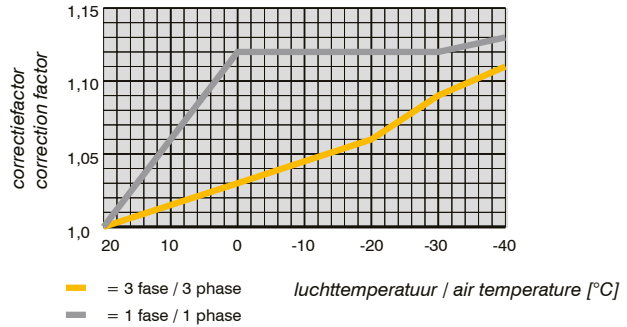

## Three phase - 50 Hz

Fan type	Tension V	$\Delta$				Y				Wiring diagram blow-through/ draw-through
		Speed min <sup>-1</sup>	Input Watt	FLC A	Sound power indication each fan LwA (+/-2dB(A)) dB(A)	Seed min <sup>-1</sup>	Input Watt	FLC A	Sound power indication each fan LwA (+/-2dB(A)) dB(A)	
<b>4 pole (n=1500 min<sup>-1</sup> nom.)</b>										
FN040	3x400/690	1370	230	0.44	76	1110	170	0.27	70,5	108B/108A
FN045	3x400/690	1250	350	0.64	78	950	220	0.35	70	108B/108A
FN050	3x400/690	1330	830	1.45	81	940	550	0.97	75	108B/108A
FN056	3x400/690	1280	1050	2.20	85	920	580	1.10	76	108B/108A
FE063	3x400/690	1330	1450	2.60	89	1080	980	1.60	84	108B/108A
<b>6 pole (n=1000 min<sup>-1</sup> nom.)</b>										
FN045	3x400/690	860	180	0.39	67	640	100	0.19	61	108B/108A
FN050	3x400/690	870	290	0.74	72	590	150	0.36	64	108B/108A
FN056	3x400/690	870	340	0.70	73	630	210	0.38	65	108B/108A
FN063	3x400/690	900	630	1.25	74	720	440	0.73	69	108B/108A

## Single phase - 50 Hz

Fan type	Speed min <sup>-1</sup>	Input Watt	FLC A	Sound power indication each fan LwA (+/-2dB(A)) dB(A)	Wiring diagram blow-through/ draw-through
<b>4 pole (n=1500 min<sup>-1</sup> nom.)</b>					
FN040	1350	240	1.10	76	104B/104A
FN045	1290	390	1.75	80	104B/104A
FN050	1230	750	3.35	81,5	104B/104A
<b>6 pole (n=1000 min<sup>-1</sup> nom.)</b>					
FN040	950	130	0.58	68	104B/104A
FN045	860	180	0.82	68,5	104B/104A
FN050	910	300	1.30	71,5	104B/104A

## Wiring diagram fans for blow-through air coolers

### Ziehl Abegg 1x230V-50Hz (104XB)

U1 = bruin  
 U2 = blauw  
 Z1 = zwart  
 Z2 = oranje  
 TB = wit

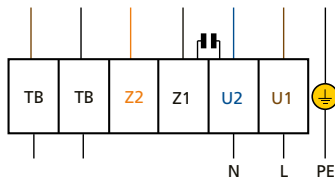

## Wiring diagram fans for draw-through air coolers

### Ziehl Abegg 1x230V-50Hz (104XA)

U1 = bruin  
 U2 = blauw  
 Z1 = zwart  
 Z2 = oranje  
 TB = wit

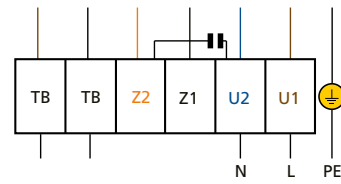

### Ziehl Abegg 3x400V (Δ)-50Hz (108XB)

U1 = bruin  
 V1 = blauw  
 W1 = zwart  
 U2 = rood  
 V2 = grijs  
 W2 = oranje  
 TB = wit

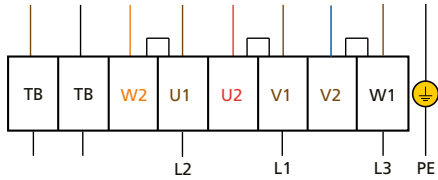

### Ziehl Abegg 3x400V (Δ)-50Hz (108XA)

U1 = bruin  
 V1 = blauw  
 W1 = zwart  
 U2 = rood  
 V2 = grijs  
 W2 = oranje  
 TB = wit

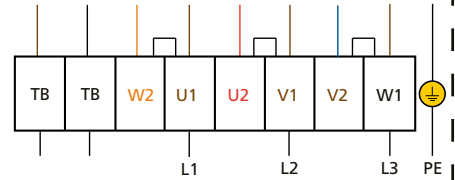

### Ziehl Abegg 3x400V (Y)-50Hz (108XB)

U1 = bruin  
 V1 = blauw  
 W1 = zwart  
 U2 = rood  
 V2 = grijs  
 W2 = oranje  
 TB = wit

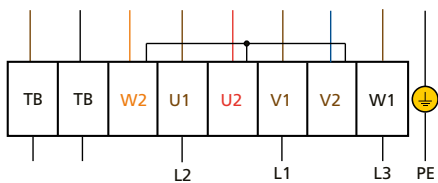

### Ziehl Abegg 3x400V (Y)-50Hz (108XA)

U1 = bruin  
 V1 = blauw  
 W1 = zwart  
 U2 = rood  
 V2 = grijs  
 W2 = oranje  
 TB = wit

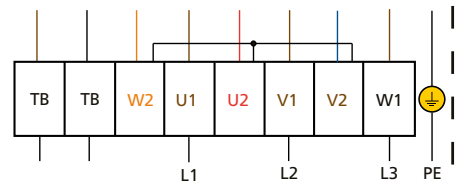

## Fan heating

To prevent the freezing of the impeller of the fan during the defrost cyclus of the air cooler, a fan heater can be used.

Fan diameter	Diameter element	Power (230V)
mm	D in mm	kW
400	435	0,50
450	485	0,63
500	535	0,63
560	595	0,76
630	665	0,89

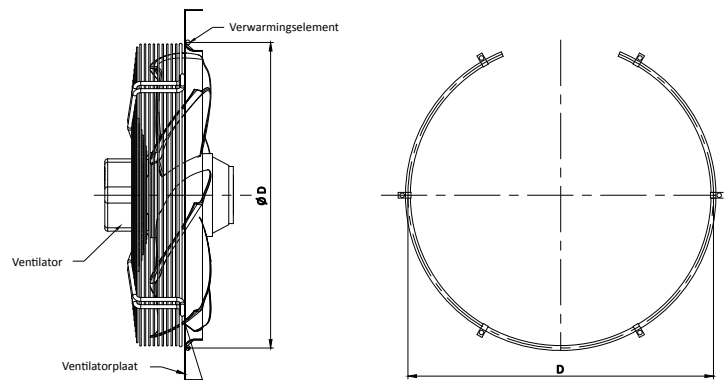

# Correction factors

## Correction factors DT1 (=air-on)

The capacities are based on R-404A direct expansion, DT1 and a RH of 85 %. DT1 is the difference between air-on temperature and the evaporation temperature of the cooler. The evaporation temperature is the saturate temperature corresponding to the pressure at the suction outlet of the cooler.

The nominal capacities:

- (SC1)  $t_o=0^{\circ}\text{C}$  and  $\text{DT1}=10\text{K}$
- (SC2)  $t_o=-8^{\circ}\text{C}$  and  $\text{DT1}=8\text{K}$
- (SC3)  $t_o=-25^{\circ}\text{C}$  and  $\text{DT1}=7\text{K}$

Correction factors for various air-on temperatures and temperature differences (DT1) are as indicated in the table below. The requested capacity must be multiplied by a correction factor from the table, so that a cooler with the resulting nominal capacity can be chosen from the selection tables.

$Q_{\text{nominal}} = \text{factor} \times Q_{\text{requested}}$

### Cooling

DT1	SC1-DT1 =10K-Air-on=10°C (0/+10)									
	Evaporation temperature (°C)									
K	+7	+6	+5	+4	+3	+2	+1	0	-1	-2
6	1,87	1,87	1,87	1,88	1,88	1,89	1,89	1,89	1,89	1,90
7	1,53	1,53	1,54	1,54	1,54	1,55	1,55	1,55	1,55	1,56
8	1,28	1,28	1,28	1,29	1,29	1,30	1,30	1,30	1,30	1,31
9	1,11	1,11	1,11	1,12	1,12	1,13	1,13	1,13	1,13	1,14
10	0,98	0,98	0,98	0,99	0,99	0,99	1,00	1,00	1,00	1,01
11	0,89	0,89	0,89	0,90	0,90	0,91	0,91	0,91	0,91	0,92
12	0,78	0,79	0,79	0,79	0,80	0,80	0,80	0,80	0,80	0,81

### Cooling / Freezing

DT1	SC2-DT1 =8K-Air-on=0°C (-8/0)									
	Evaporation temperature (°C)									
K	-3	-4	-5	-6	-7	-8	-9	-10	-11	-12
6	1,32	1,34	1,39	1,43	1,46	1,46	1,47	1,47	1,48	1,49
7	1,05	1,08	1,12	1,15	1,18	1,19	1,19	1,20	1,20	1,21
8	0,86	0,88	0,91	0,94	0,97	1,00	1,00	1,01	1,01	1,02
9	0,76	0,76	0,78	0,80	0,82	0,86	0,86	0,87	0,87	0,88
10	0,66	0,67	0,69	0,71	0,73	0,74	0,74	0,75	0,75	0,76
11	0,58	0,59	0,59	0,60	0,62	0,64	0,64	0,65	0,66	0,67
12	0,55	0,54	0,54	0,54	0,55	0,55	0,56	0,57	0,58	0,59

### Freezing

DT1	SC3-DT1 =7K-Air-on=-18°C (-25/-18)									
	Evaporation temperature (°C)									
K	-21	-22	-23	-24	-25	-26	-27	-28	-29	-30
6	1,20	1,20	1,21	1,21	1,22	1,22	1,23	1,23	1,24	1,24
7	0,99	0,99	0,99	1,00	1,00	1,00	1,01	1,01	1,02	1,02
8	0,83	0,84	0,84	0,84	0,85	0,85	0,85	0,85	0,86	0,86
9	0,72	0,72	0,72	0,73	0,73	0,73	0,73	0,74	0,74	0,74
10	0,63	0,63	0,63	0,64	0,64	0,64	0,64	0,65	0,65	0,65
11	0,56	0,56	0,56	0,57	0,57	0,57	0,50	0,58	0,58	0,58
12	0,50	0,51	0,51	0,51	0,51	0,51	0,52	0,52	0,52	0,52

### Calculation example

Fin spacing	: 6 mm	-	DT1 = +3- (+10) = 7K
Required capacity	: 30 kW	-	Correction factor = 1,54
Air-on temperature	: +10 °C	-	Multiply required capacity with correction factor.
Refrigeration temp.	: +3 °C		30 kW x 1,54 = 46,2 kW
Condition	: SC1		
Refrigerant	: R-404A	-	Select air cooler from the table (SC1 type VCI-B 63506=47,5 kW)

# Attention!



#### Moisture carry over from the coil block:

When you select VCI-B with a Ø500 mm fan in an application with a high relative humidity and/or defrost with room air, Goedhart advises the use of a fan with a low pitch angle or the draw-through execution VCI-Z. Thus, you will avoid the risk of moisture carry over from the coil block. The fan with a low pitch angle give a reducing of the capacity of approx. 5% and a reduction of the air volume of approx. 10%.

#### Air throw\*\* (only draw-through execution)

The air throw mentioned in the selection table indicated with \*\* is based on an air temperature of 20°C, blowing under a flat ceiling without any obstruction. The height and air circulation fold of the room can influence the air throw. The air speed at the end of the throw-length is 0,25 m/sec

# Goedhart VCI 10mm

	Type VCI	3x400V-50H-4pole (1500 min <sup>-1</sup> nom.)					Air volume m <sup>3</sup> /h	LpA @ 3 m (+/- 2 dB(A))*	Surface m <sup>2</sup>	Internal volume dm <sup>3</sup>	Weight kg	Dimensions								Connections							
		R404A			Air volume m <sup>3</sup> /h	LpA @ 3 m (+/- 2 dB(A))*						Surface m <sup>2</sup>	Internal volume dm <sup>3</sup>	Weight kg	L mm	B mm	H mm	C mm	E E1 mm	E2 mm	E3 mm	D1 mm	D2 mm	Refrigerant			
		DT1 = 10K (SC1) air on= 0°C (0/+10)	DT1 = 8K (SC2) air on= 0°C (-8/0)	DT1 = 7K (SC3) air on= -18°C (-25/-18)																				In mm	Uit mm	Hot gas mm	Air throw** m
		kW	kW	kW																							
	6.1.40.10		4,0	3,0	3455	54,3	24	9	82	1156	740	620	600	756			578		15	15	19	20					
	8.1.40.10		5,4	3,9	3346	54,3	32	11	95	1156	840	620	700	756			578		12	15	19	20					
	1.1.40.10		6,2	4,3	3239	54,3	40	14	108	1156	940	620	800	756			578		12	22	19	20					
	6.1.45.10		6,5	4,6	5255	56,2	33	12	98	1256	710	720	600	856			628		12	22	19	22,5					
	8.1.45.10		7,7	5,6	5066	56,2	44	16	114	1256	810	720	700	856			628		12	22	19	22,5					
	1.1.45.10		9,0	6,4	4886	56,2	55	19	129	1256	910	720	800	856			628		12	22	19	22,5					
	6.1.50.10		8,5	6,2	7378	59,1	41	15	126	1456	830	720	700	1056			728		12	22	19	25					
	8.1.50.10		10,5	7,5	7162	59,1	55	19	145	1456	930	720	800	1056			728		12	22	19	25					
	1.1.50.10		12,2	8,7	6959	59,1	69	24	164	1456	1030	720	900	1056			728		12	28	19	25					
	6.1.56.10		12,4	8,9	10410	62,8	60	21	167	1556	930	920	800	1156			778		12	28	19	27,5					
	8.1.56.10		14,8	10,2	10158	62,8	81	28	192	1556	1030	920	900	1156			778		12	28	19	27,5					
	1.1.56.10		17,3	12,0	9926	62,8	101	35	217	1556	1130	920	1000	1156			778		12	28	19	27,5					
	6.1.63.10		16,0	11,4	12814	66,6	82	29	215	1656	945	1120	800	1256			828		12	28	19	27,5					
8.1.63.10		18,7	13,8	12609	66,6	110	38	247	1656	1045	1120	900	1256			828		12	35	19	27,5						
1.1.63.10		22,7	16,3	12404	66,6	137	47	277	1656	1145	1120	1000	1256			828		16	35	19	27,5						
	6.2.40.10		8,9	6,4	6903	57,0	48	17	131	1856	740	620	600	1456			928		12	22	19	20					
	8.2.40.10		10,7	7,8	6684	57,0	64	22	152	1856	840	620	700	1456			928		12	22	19	20					
	1.2.40.10		12,3	8,8	6468	57,0	80	28	172	1856	940	620	800	1456			928		12	28	19	20					
	6.2.45.10		12,9	9,2	10503	58,9	66	23	159	2056	710	720	600	1656			1028		12	28	19	22,5					
	8.2.45.10		15,4	11,2	10121	58,9	88	30	185	2056	810	720	700	1656			1028		16	28	19	22,5					
	1.2.45.10		18,0	12,8	9758	58,9	110	38	212	2056	910	720	800	1656			1028		16	28	19	22,5					
	6.2.50.10		16,9	12,4	14751	61,7	82	29	212	2456	830	720	700	2056			1228		16	28	19	25					
	8.2.50.10		21,0	15,0	14314	61,7	110	38	244	2456	930	720	800	2056			1228		16	35	19	25					
	1.2.50.10		24,4	17,4	13907	61,7	137	47	275	2456	1030	720	900	2056			1228		16	35	19	25					
	6.2.56.10		24,7	17,8	20813	65,4	121	42	282	2656	930	920	800	2256			1328		16	35	19	27,5					
	8.2.56.10		29,8	20,5	20304	65,4	161	55	326	2656	1030	920	900	2256			1328		16	35	35	27,5					
	1.2.56.10		34,5	24,0	19842	65,4	201	69	370	2656	1130	920	1000	2256			1328		16	42	35	27,5					
	6.2.63.10		31,9	22,8	25621	69,2	164	57	372	2856	945	1120	800	2456			1428		16	42	35	27,5					
8.2.63.10		37,8	27,6	25210	69,2	219	75	429	2856	1045	1120	900	2456			1428		16	42	35	27,5						
1.2.63.10		42,6	31,6	24798	69,2	274	94	486	2856	1145	1120	1000	2456			1428		22	42	35	27,5						
	6.3.45.10		19,4	13,8	15751	60,4	99	34	222	2856	710	720	600	2456			1428		16	35	19	22,5					
	8.3.45.10		23,6	16,9	15176	60,4	131	45	260	2856	810	720	700	2456			1428		16	35	19	22,5					
	1.3.45.10		26,8	19,3	14632	60,4	164	57	297	2856	910	720	800	2456			1428		16	35	35	22,5					
	6.3.50.10		25,9	18,5	22121	63,1	123	43	299	3456	830	720	700	1028	2028		864	1728	16	35	19	25					
	8.3.50.10		31,1	22,5	21465	63,1	164	57	347	3456	930	720	800	1028	2028		864	1728	16	42	35	25					
	1.3.50.10		36,6	26,1	20854	63,1	205	71	393	3456	1030	720	900	1028	2028		864	1728	16	42	35	25					
	6.3.56.10		37,1	26,7	31214	66,8	181	62	397	3756	930	920	800	1128	2228		939	1878	16	42	19	27,5					
	8.3.56.10		45,2	32,8	30451	66,8	241	83	462	3756	1030	920	900	1128	2228		939	1878	22	42	35	27,5					
	1.3.56.10		52,7	37,7	29756	66,8	301	103	524	3756	1130	920	1000	1128	2228		939	1878	22	42	35	27,5					
	6.3.63.10		48,0	34,1	38430	70,6	246	85	529	4056	945	1120	800	1228	2428		1014	2028	22	42	35	27,5					
	8.3.63.10		58,8	42,2	37810	70,6	328	113	611	4056	1045	1120	900	1228	2428		1014	2028	22	54	35	27,5					
	1.3.63.10		67,7	48,9	37192	70,6	411	141	693	4056	1145	1120	1000	1228	2428		1014	2028	22	54	35	27,5					

\* = Sound pressure indication (LpA) at 3 m distance each air cooler (+/- 2 dB(A)), free field conditions, according EN13487

\*\* = Air throw see remark page 5

For moisture carry over see remark pag 5

Capacities and air volumes with 60 Hz fans on request or in our GPC selection program available.

# Goedhart VCI Drawing

